

# Home 2050 mind map

Jos Lichtenberg  
december 2015

Homelab 2050



# Home 2050 mind map

home  
2050

# Home 2050 mind map



# Home 2050 mind map

wonen-werken-recreëren 2015?  
aanpasbaar, toegankelijk,  
veilig, emotionele waarde (mooi, gezellig)

gebruik

home  
2050

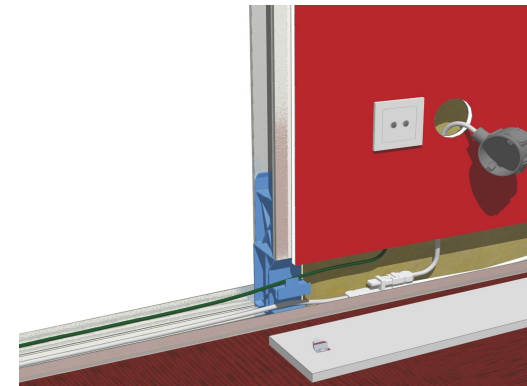
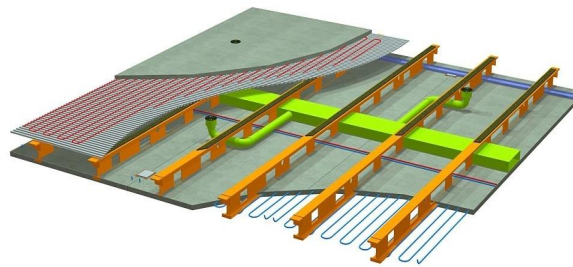
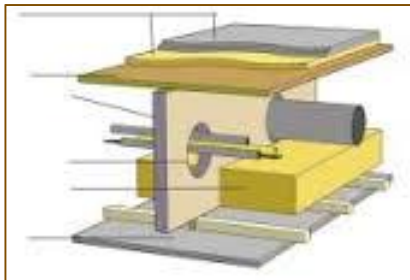

# Home 2050 mind map

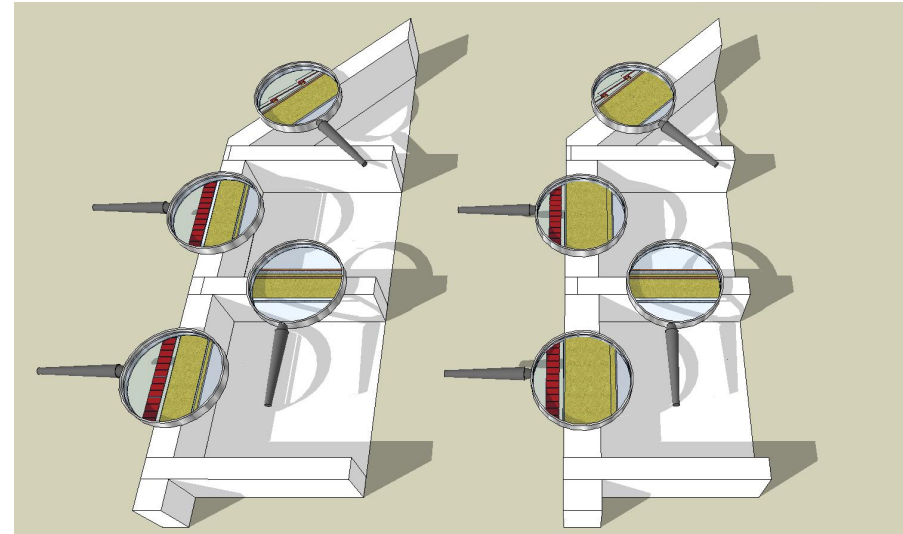

# Home 2050 mind map



# Home 2050 mind map



# Home 2050 mind map

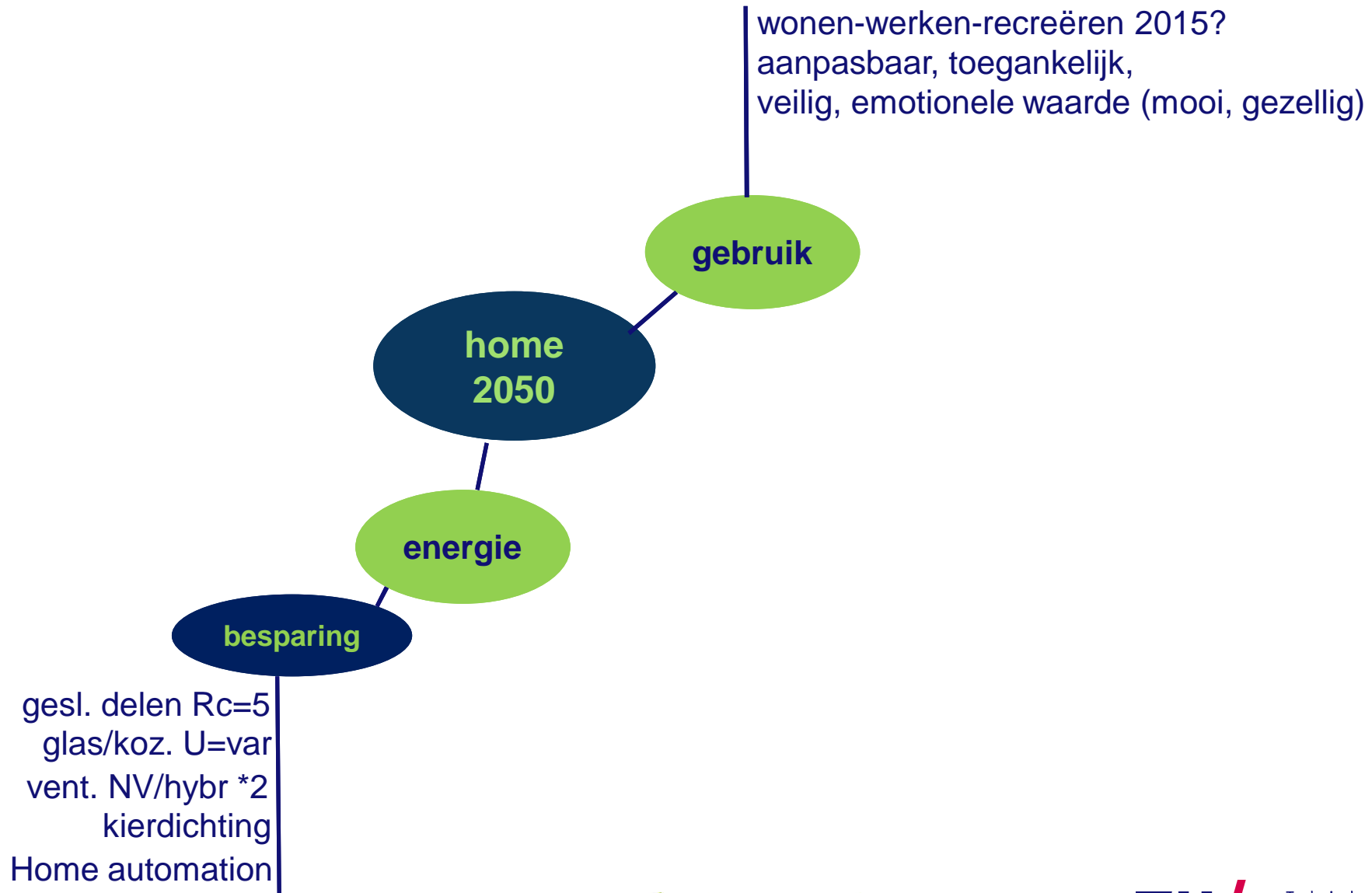



# Home 2050 mind map

wonen-werken-recreëren 2015?  
aanpasbaar, toegankelijk,  
veilig, emotionele waarde (mooi, gezellig)

gebruik

home  
2050

energie

besparing

gesl. delen  $R_c=5$   
glas/koz.  $U=var$   
vent. NV/hybr \*2  
kierdichting  
Home automation

kWh/m<sup>2</sup>/jr

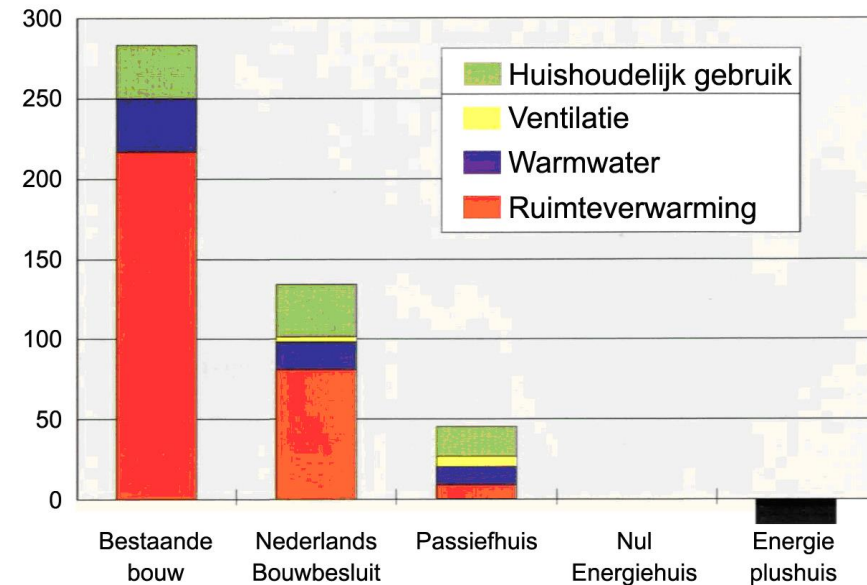

# Home 2050 mind map

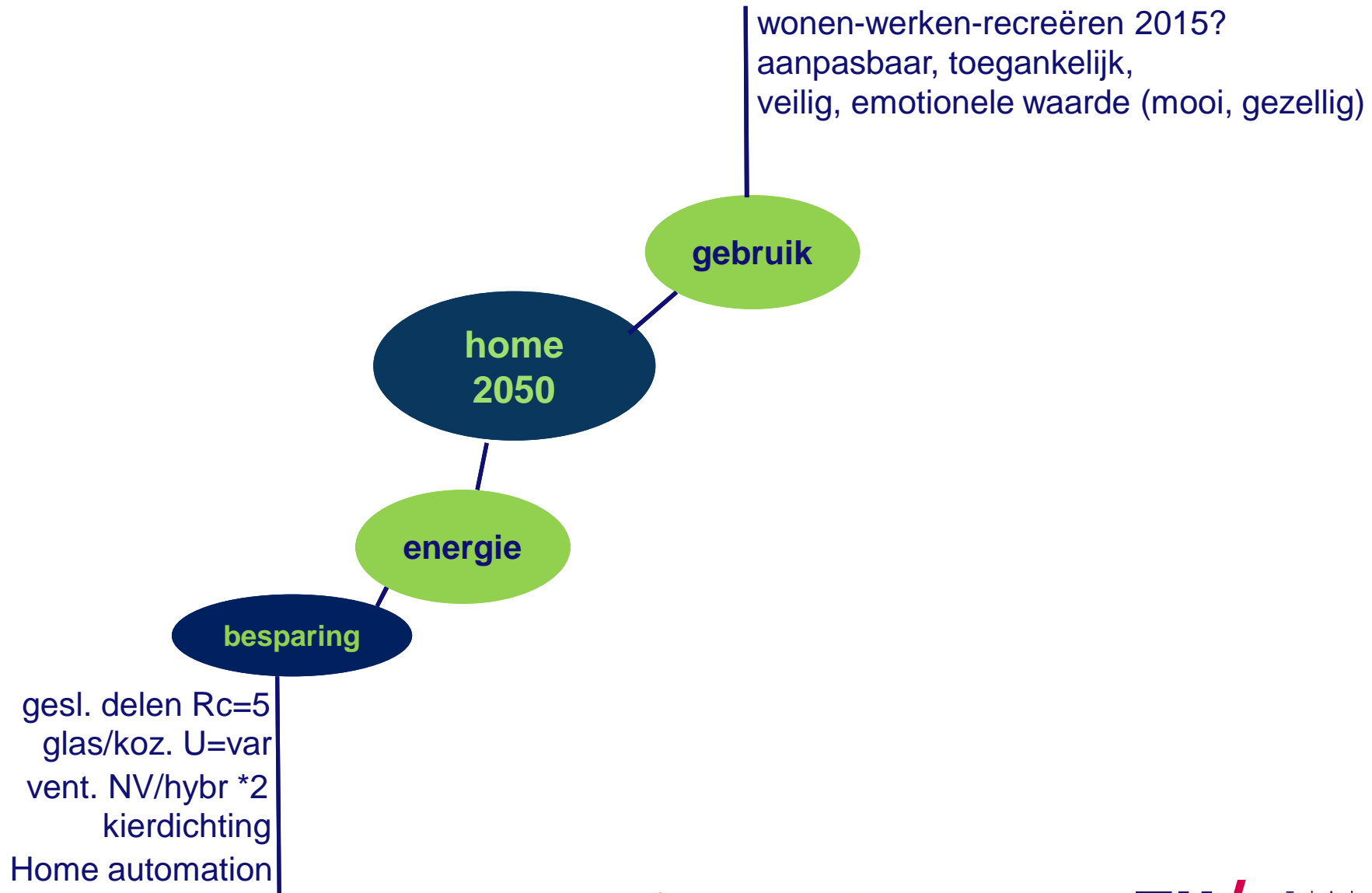

# Home 2050 mind map

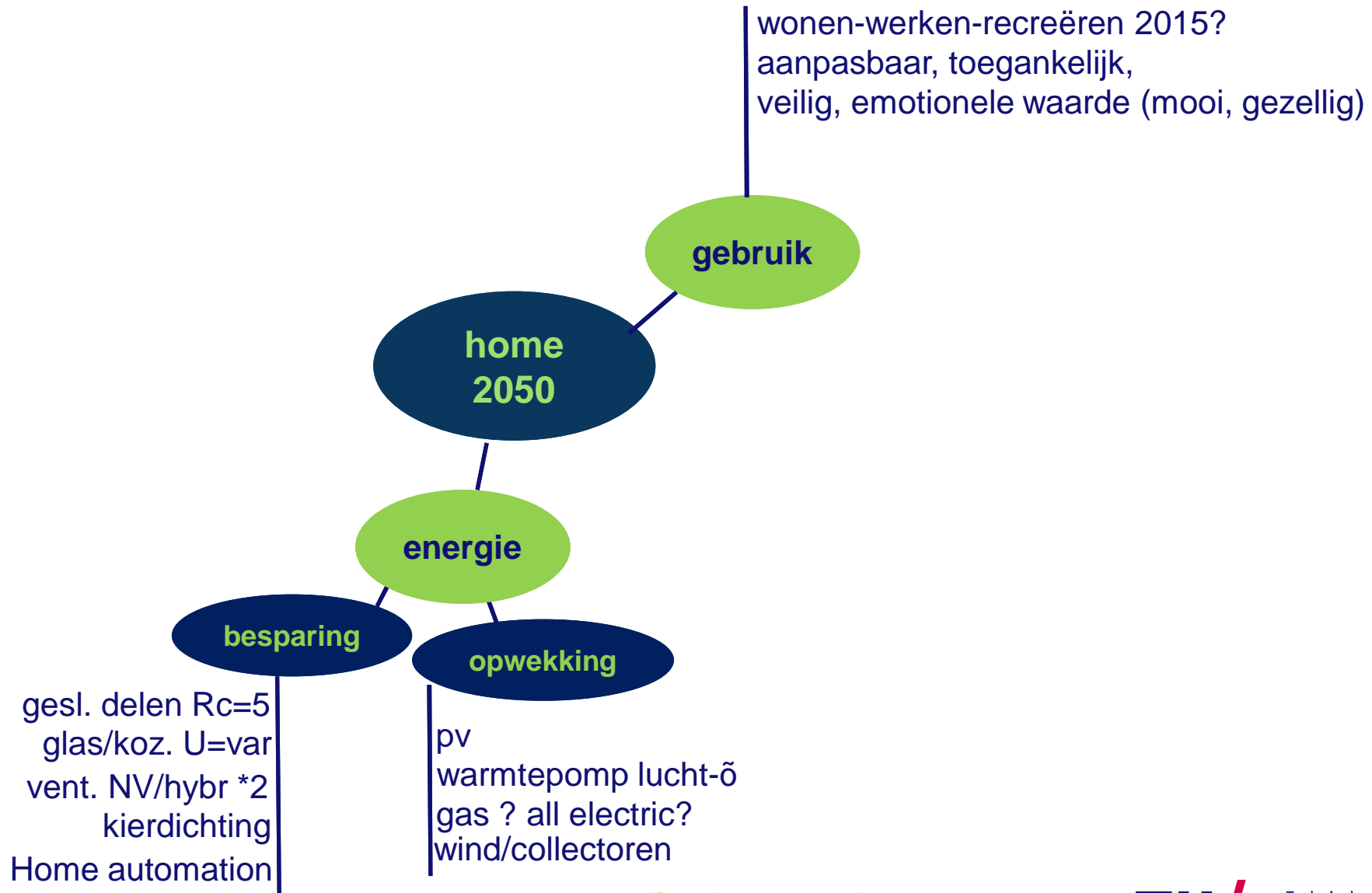

# Home 2050 mind map

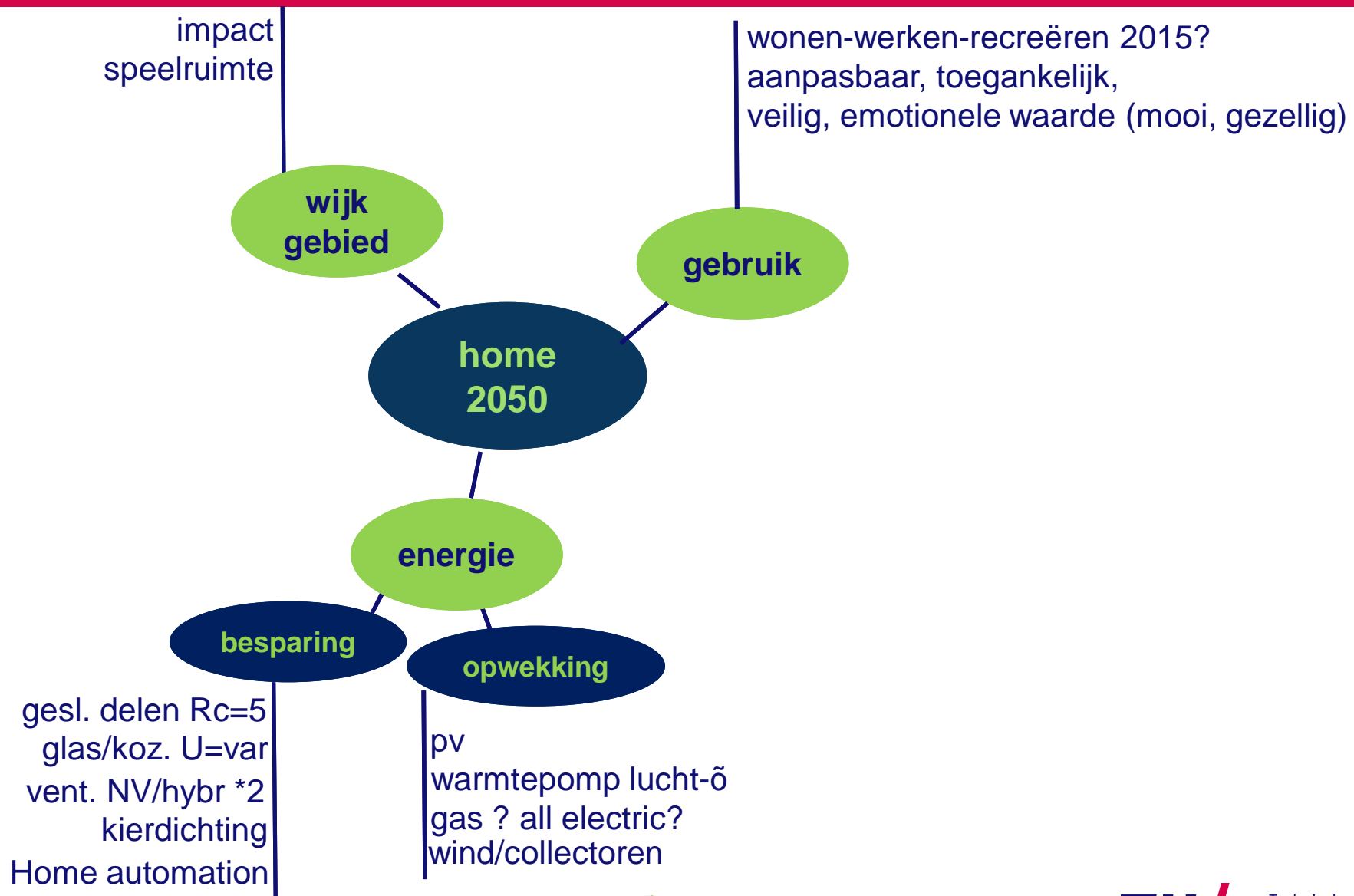

# Home 2050 mind map

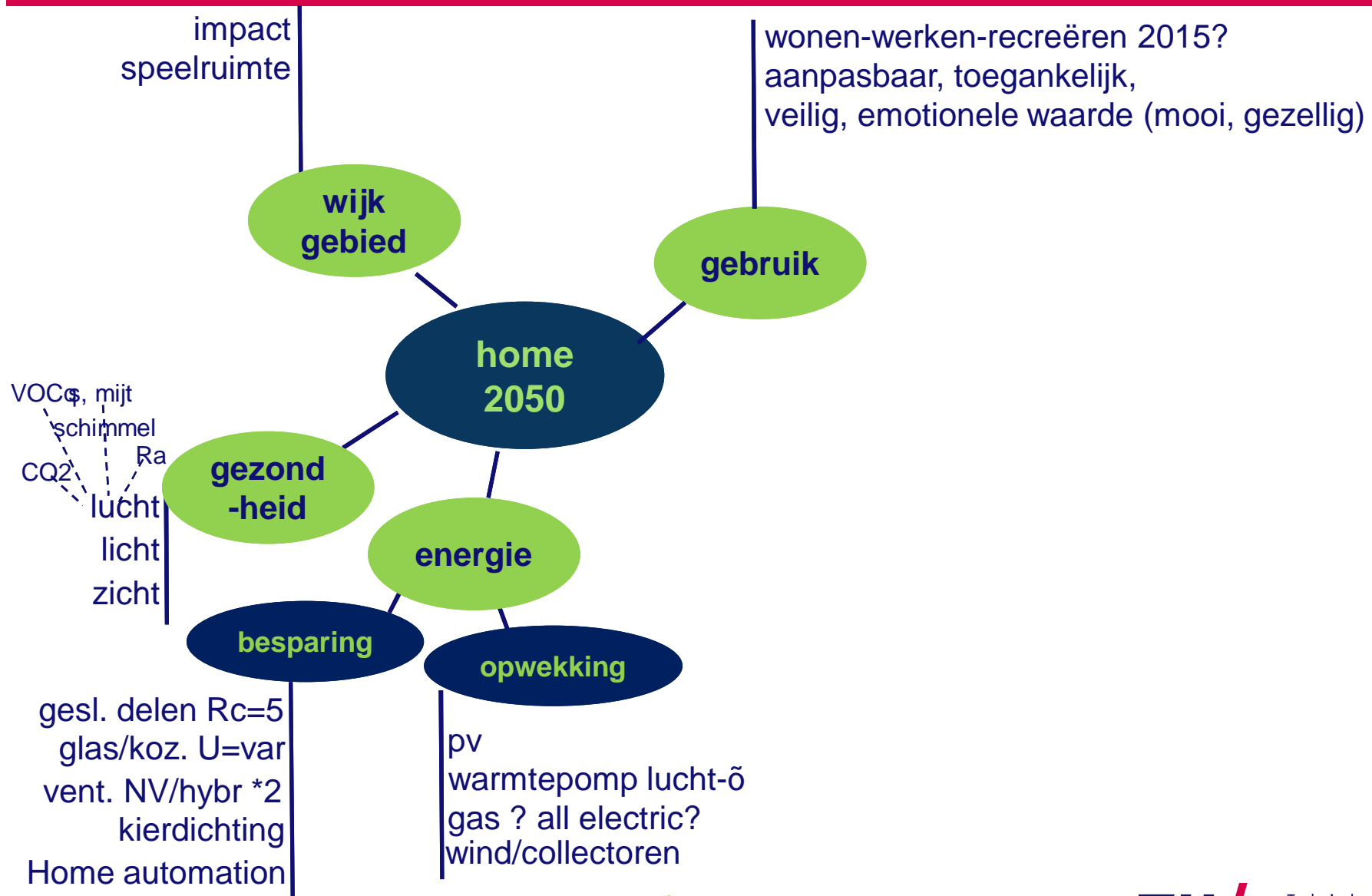

# Home 2050 mind map

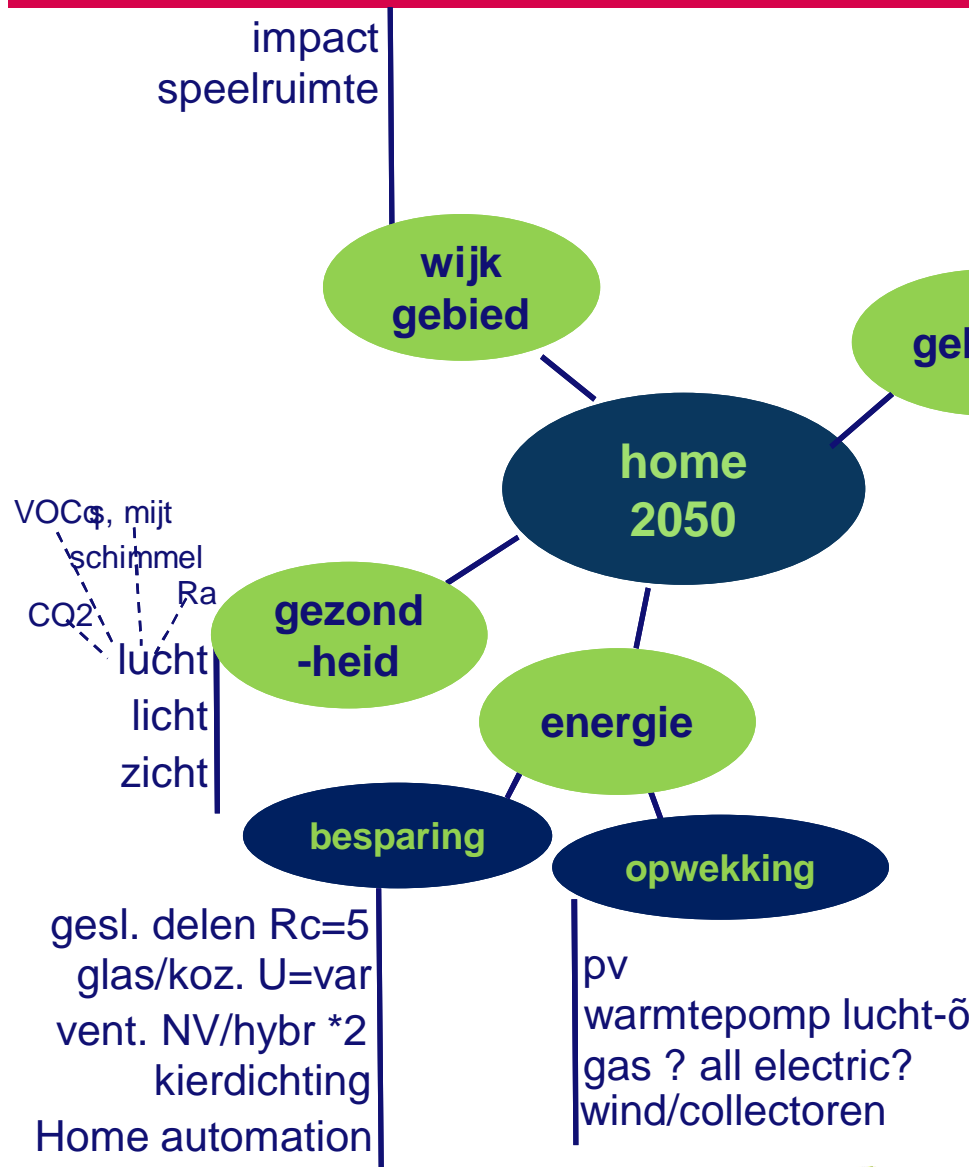

# Home 2050 mind map

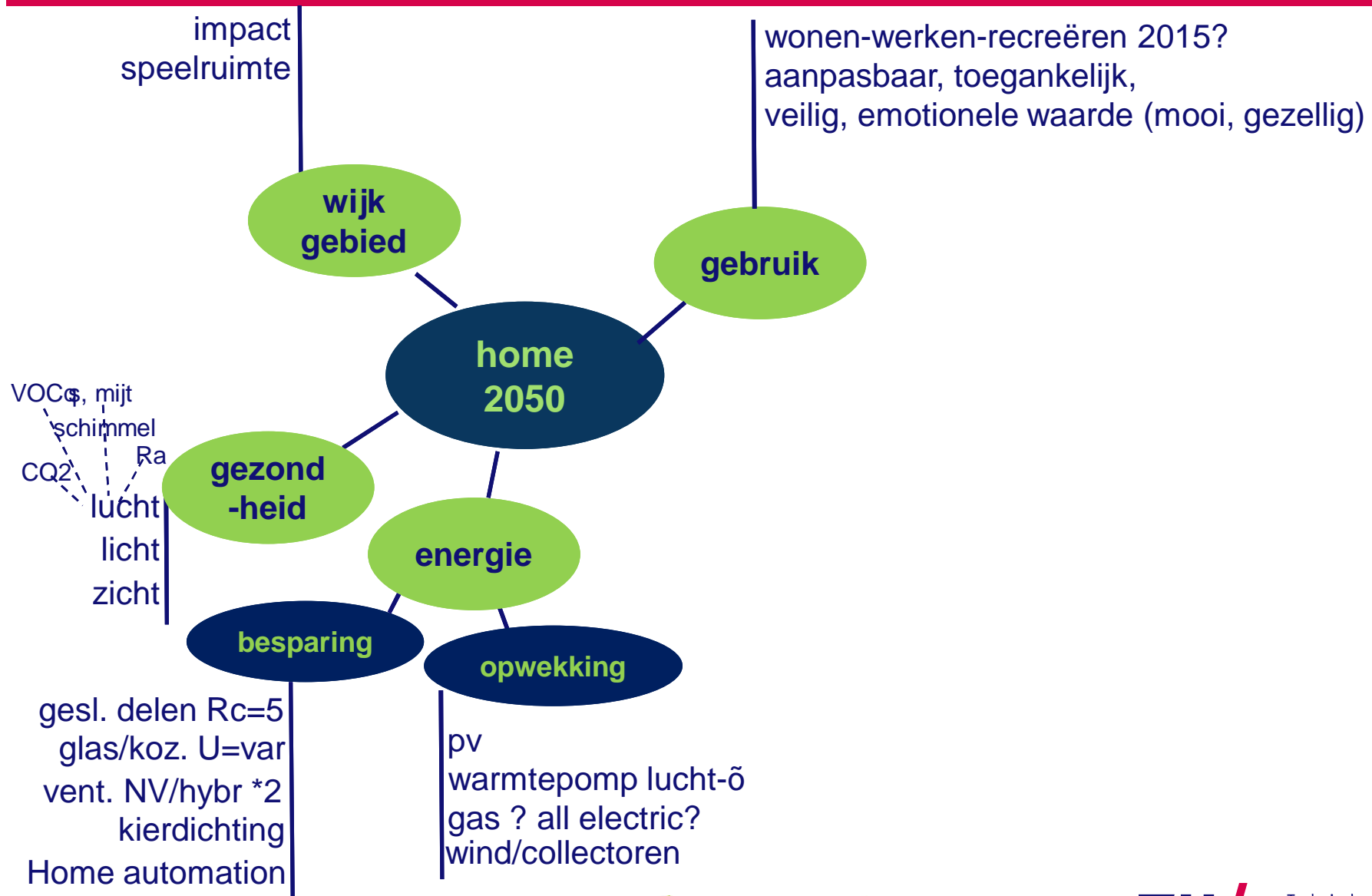

# Home 2050 mind map

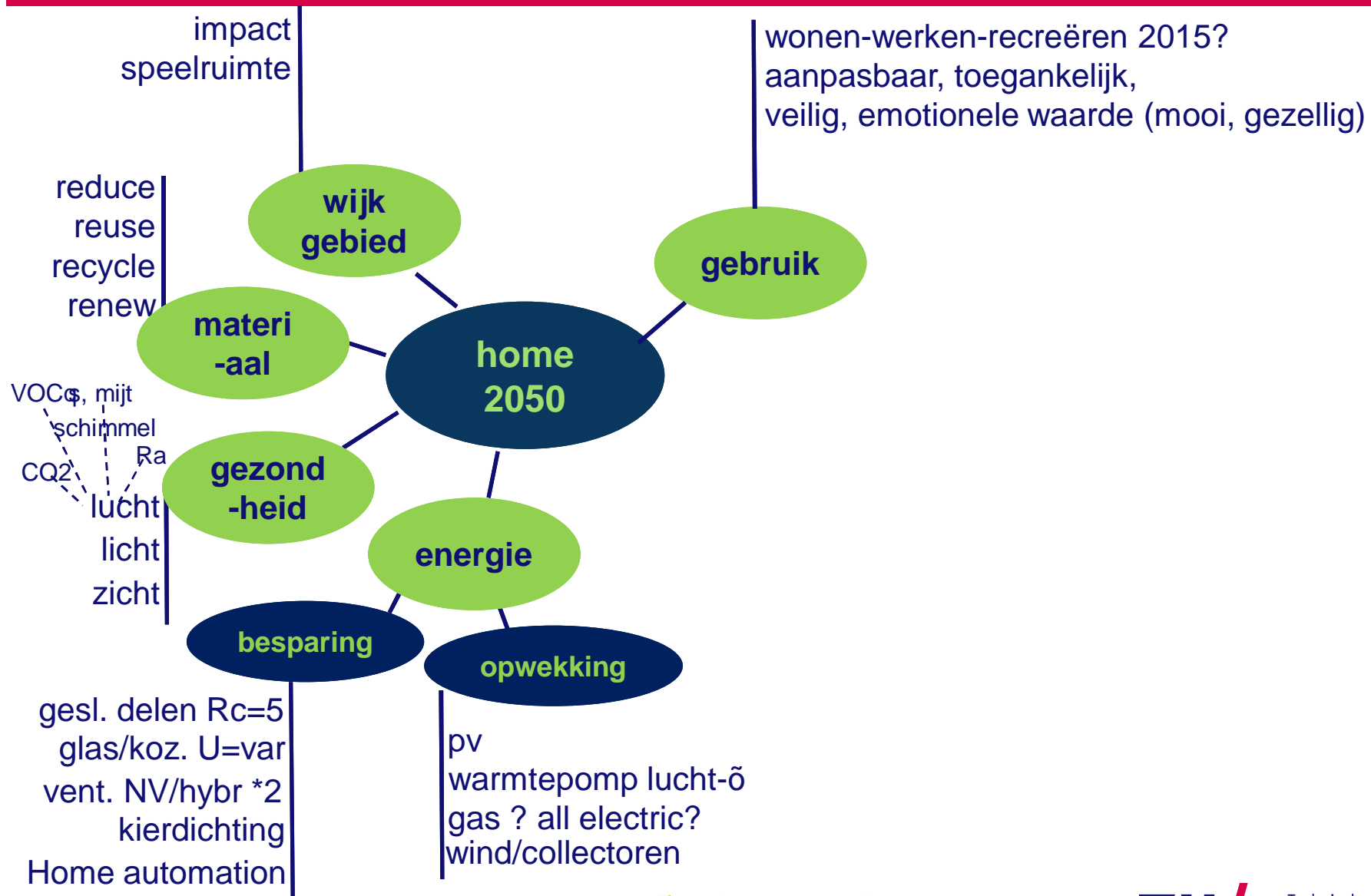



# Home 2050 mind map

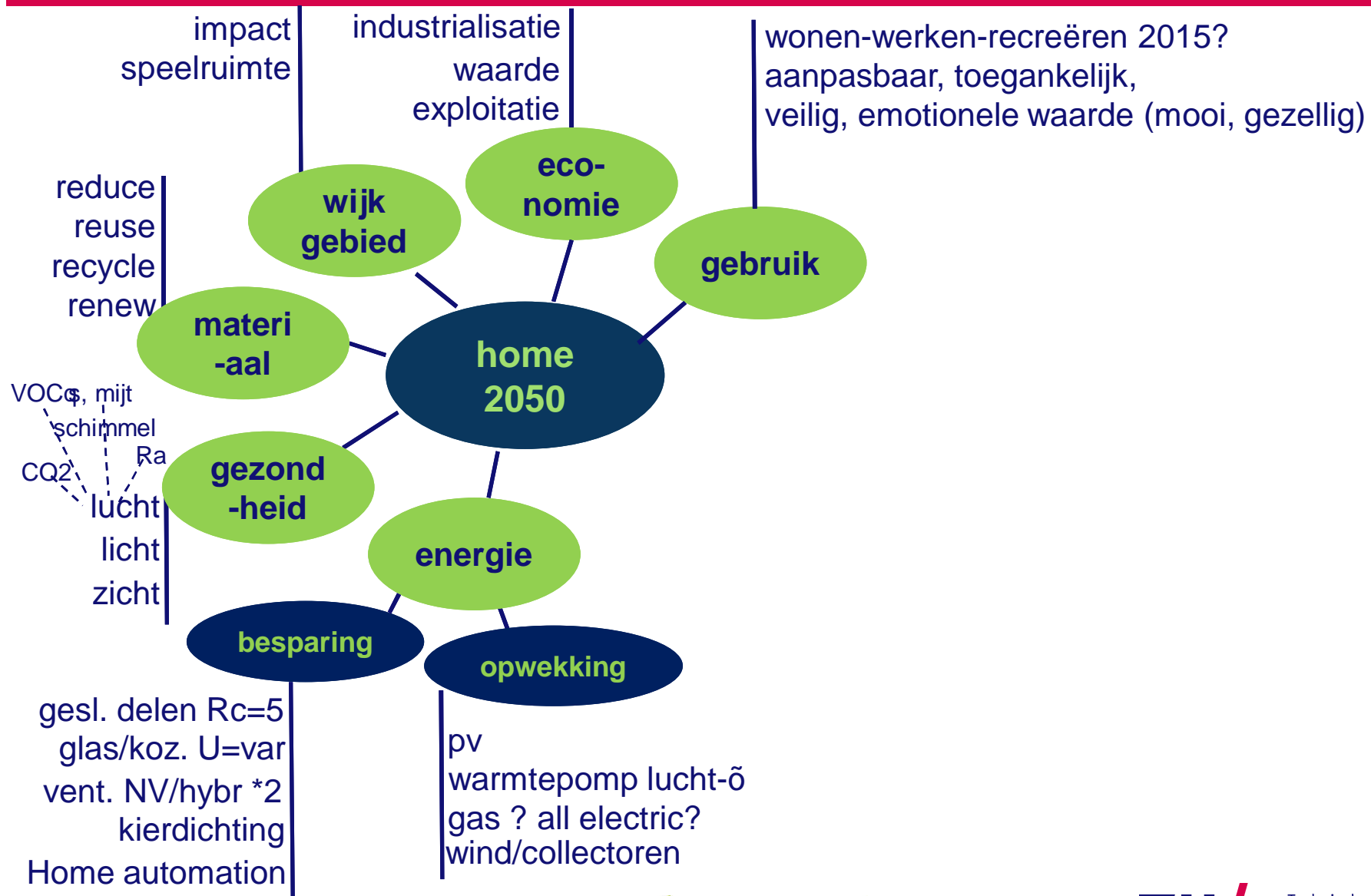

# Home 2050 mind map

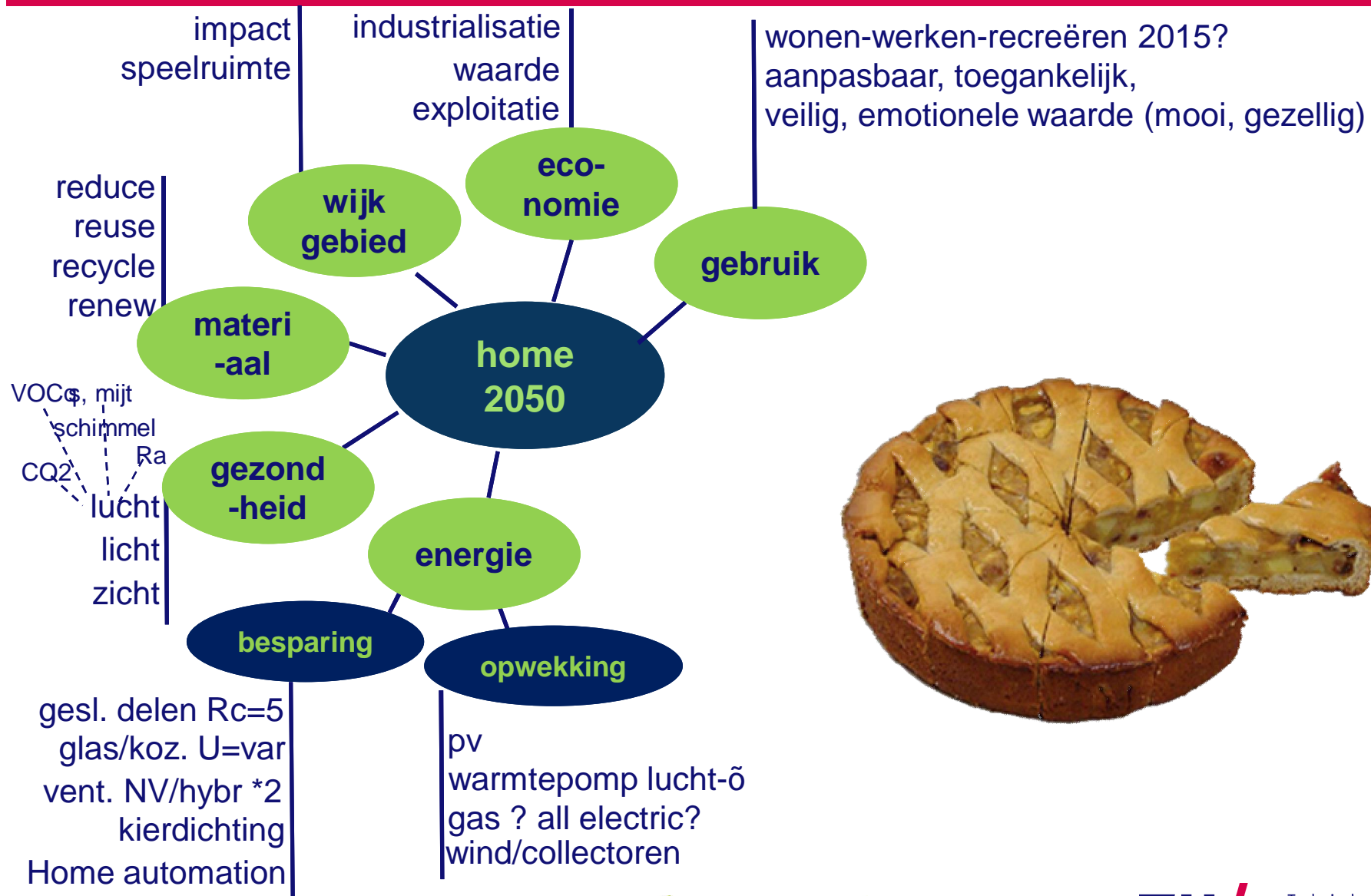

# Home 2050 mind map

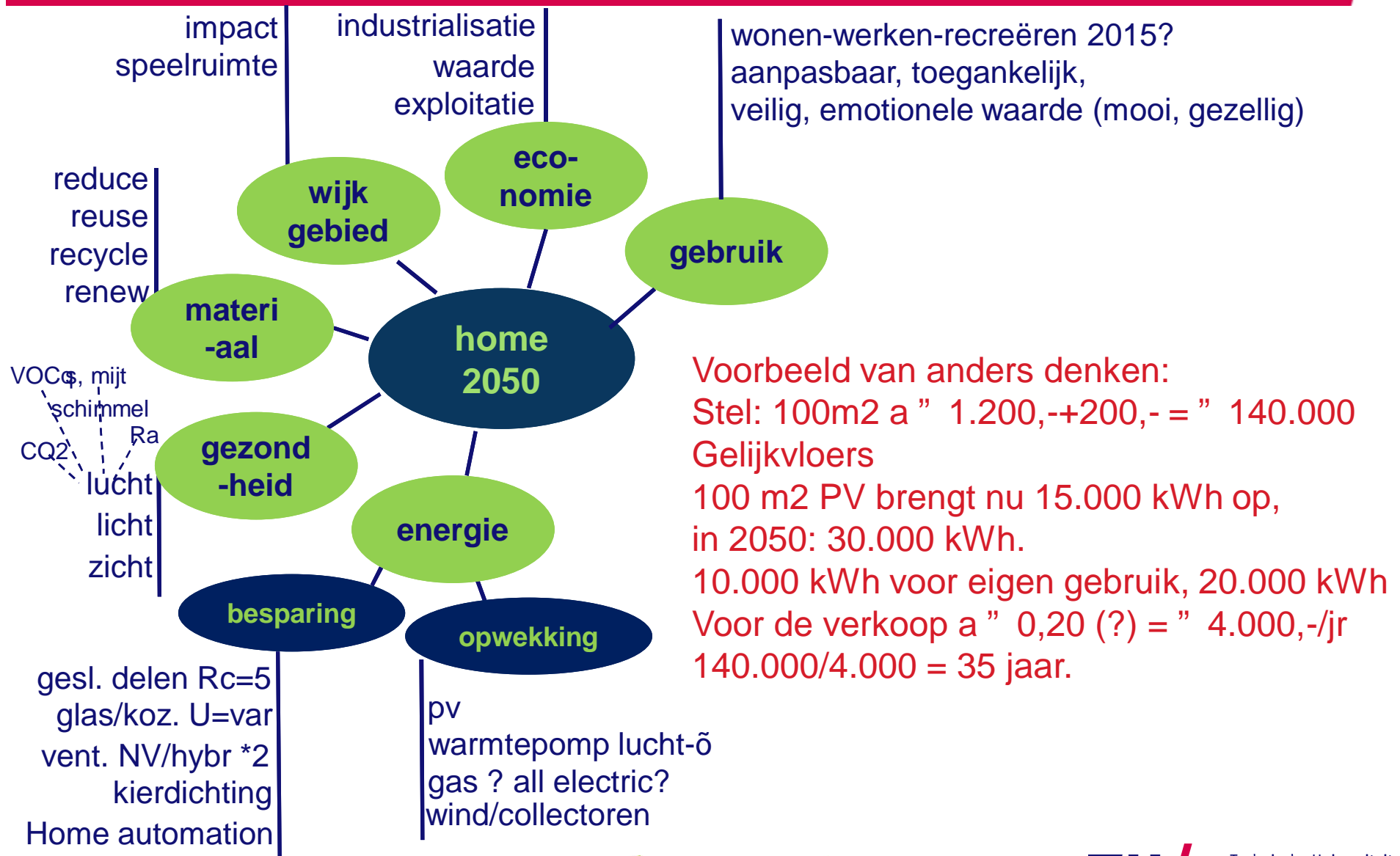

Voorbeeld van anders denken:

Stel: 100m2 a " 1.200,-+200,- = " 140.000

Geljkvloers

100 m2 PV brengt nu 15.000 kWh op, in 2050: 30.000 kWh.

10.000 kWh voor eigen gebruik, 20.000 kWh

Voor de verkoop a " 0,20 (?) = " 4.000,-/jr

140.000/4.000 = 35 jaar.



# History of Sustainability

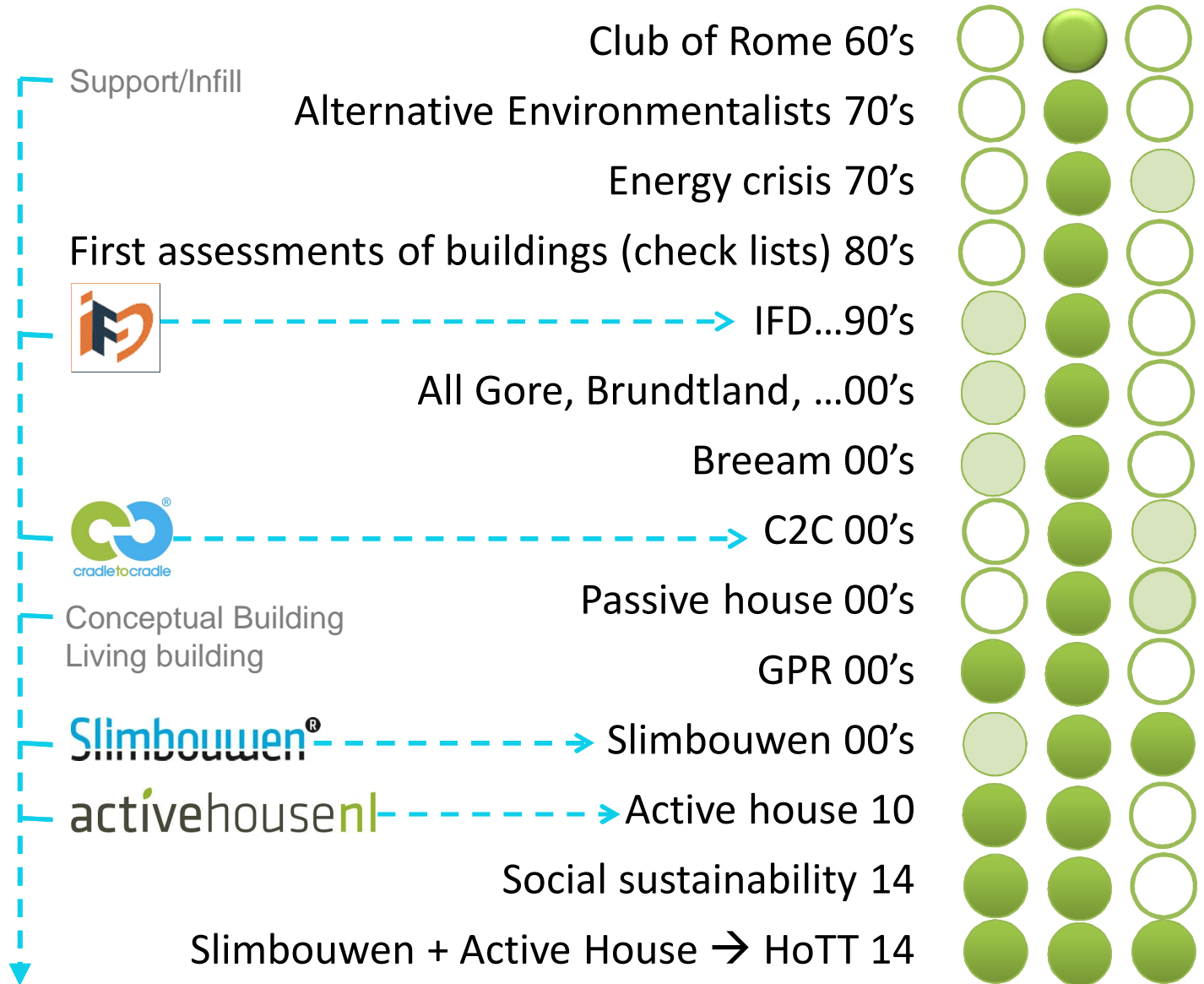
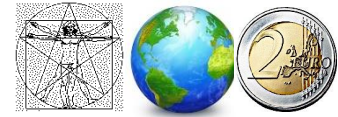

# Home 2050 mind map

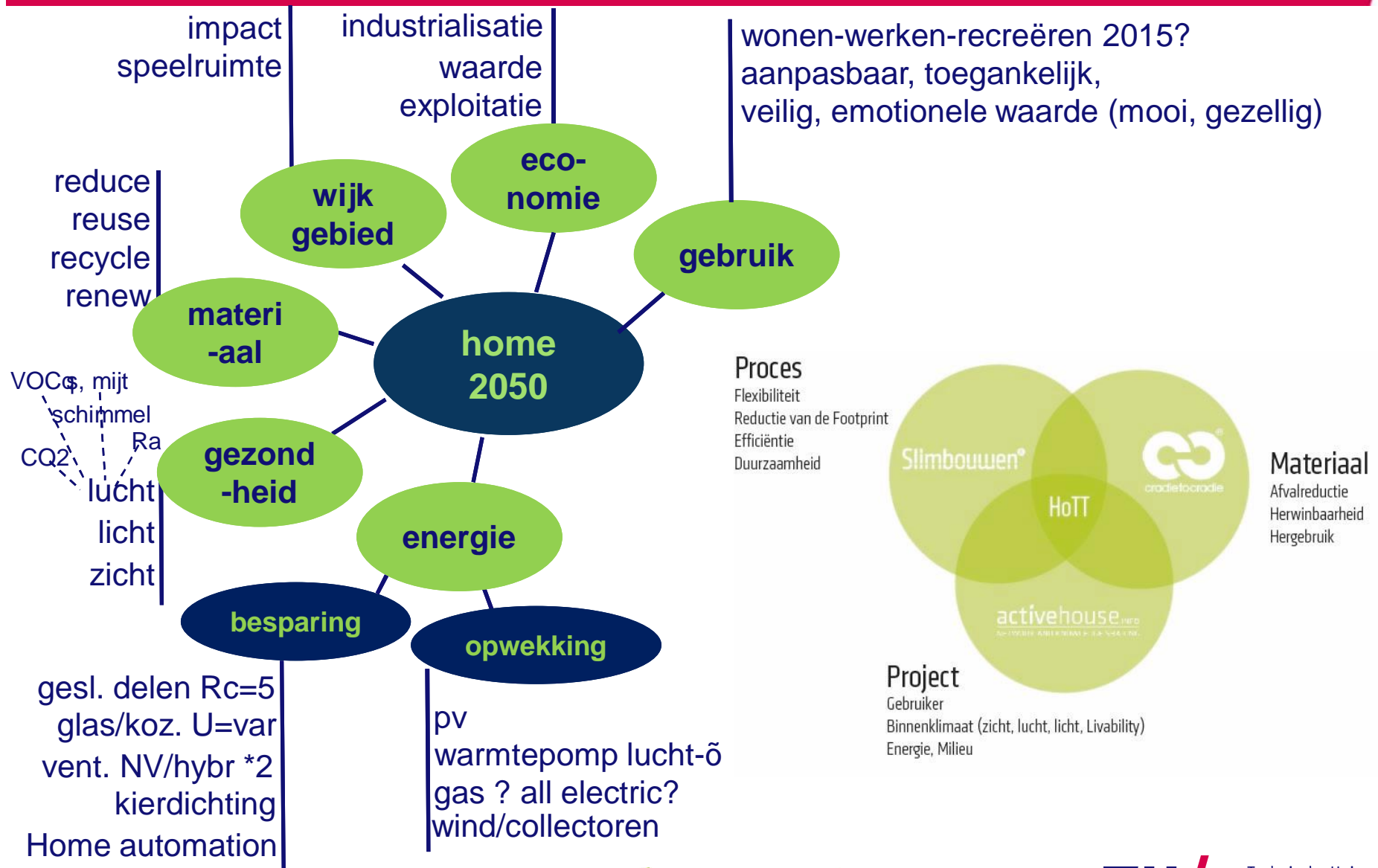

# Home 2050 mind map

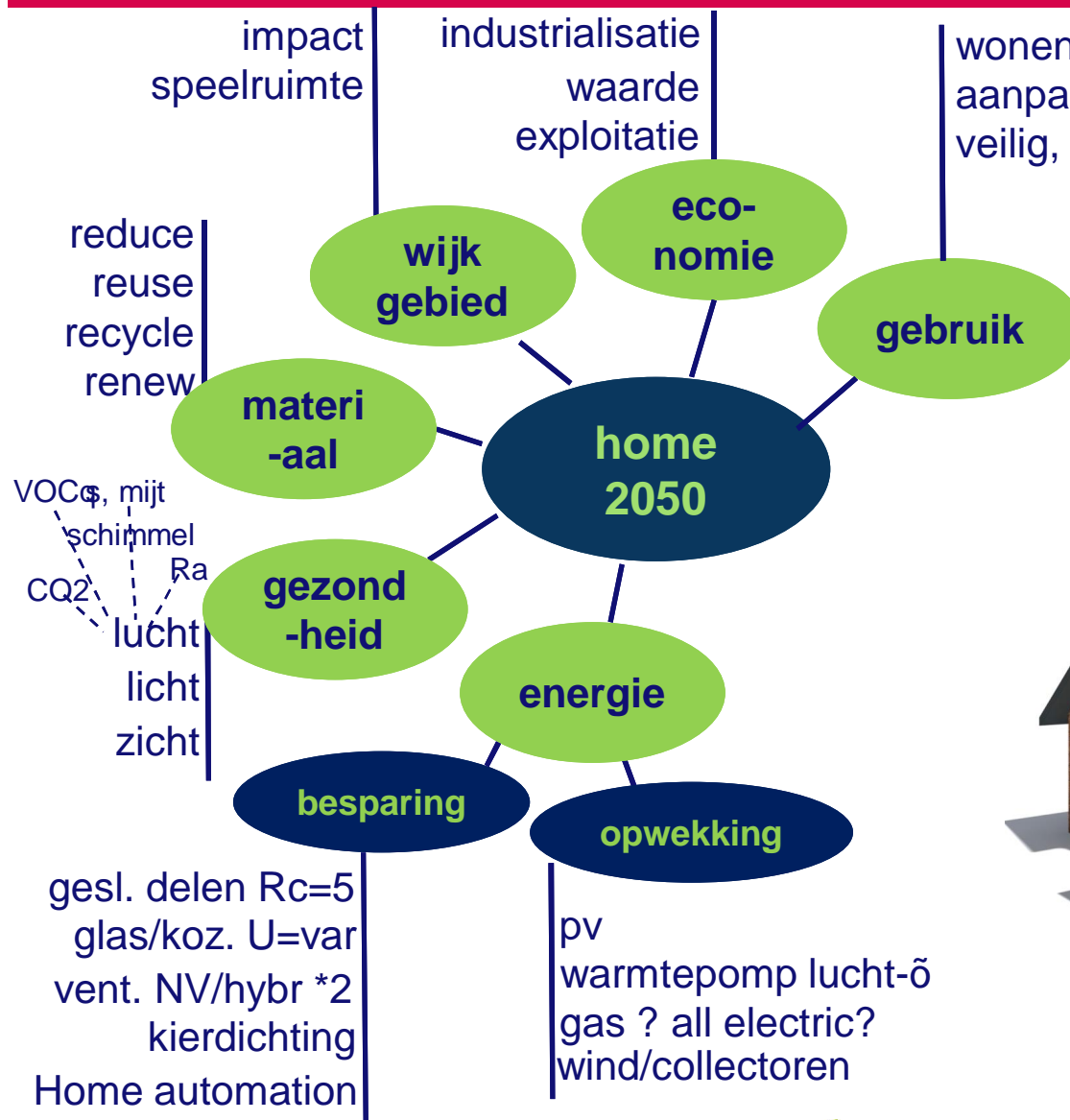

HoTT

# Home 2050 mind map

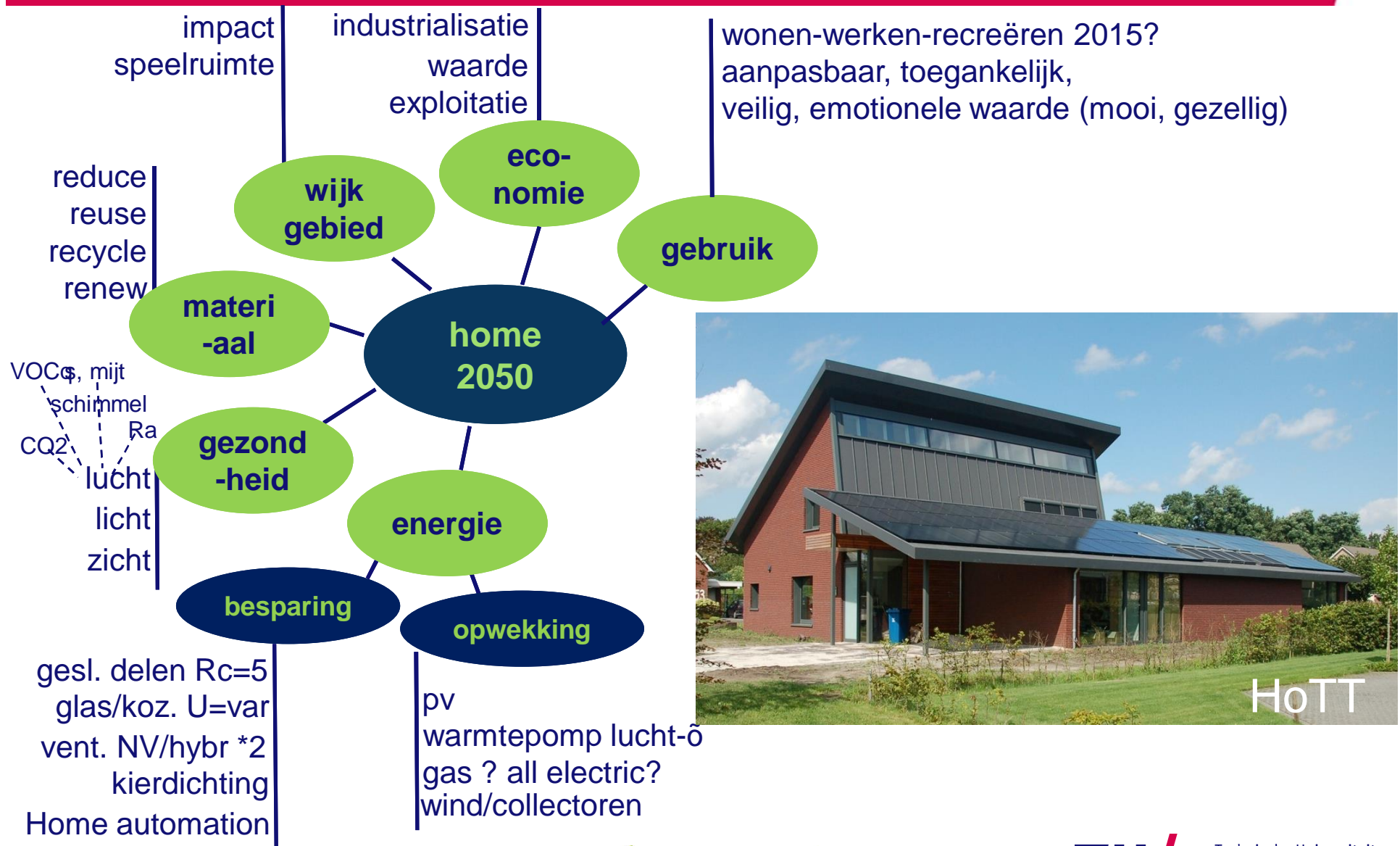



HoTT

Photos Dick Holthuis





HoTT

Photo Dick Holthuis

Photo Dick Holthuis



HoTT

Photo Dick Holthuis



HoTT



HoTT

Photo Dick Holthuis

Photo Dick Holthuis



HoTT



HoTT

Photo Dick Holthuis

Photo Dick Holthuis



HoTT

# Home 2050 mind map

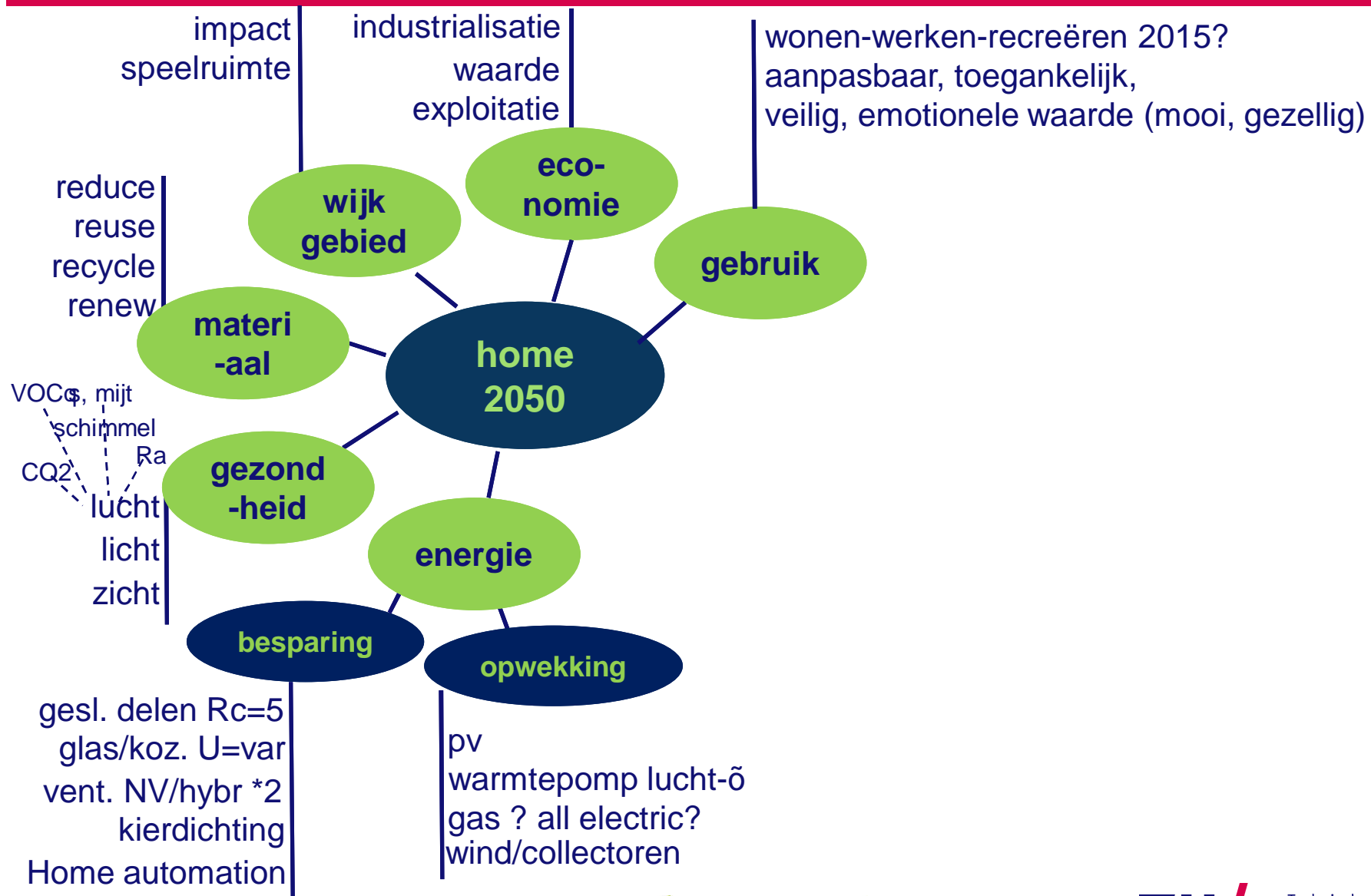



# Home 2050 mind map

